



*Up-to-date Questions and Answers from authentic resources to improve knowledge and pass the exam at very first attempt. ---- Guaranteed.*



HPE6-A49 Dumps  
HPE6-A49 Braindumps  
HPE6-A49 Real Questions  
HPE6-A49 Practice Test  
HPE6-A49 Actual Questions



[killexams.com](http://killexams.com)

**HP**

# HPE6-A49

*Aruba Certified Design Expert (ACDX) V8*

ORDER FULL VERSION

<https://killexams.com/pass4sure/exam-detail/HPE6-A49>



Question: 45

Refer to the exhibit.

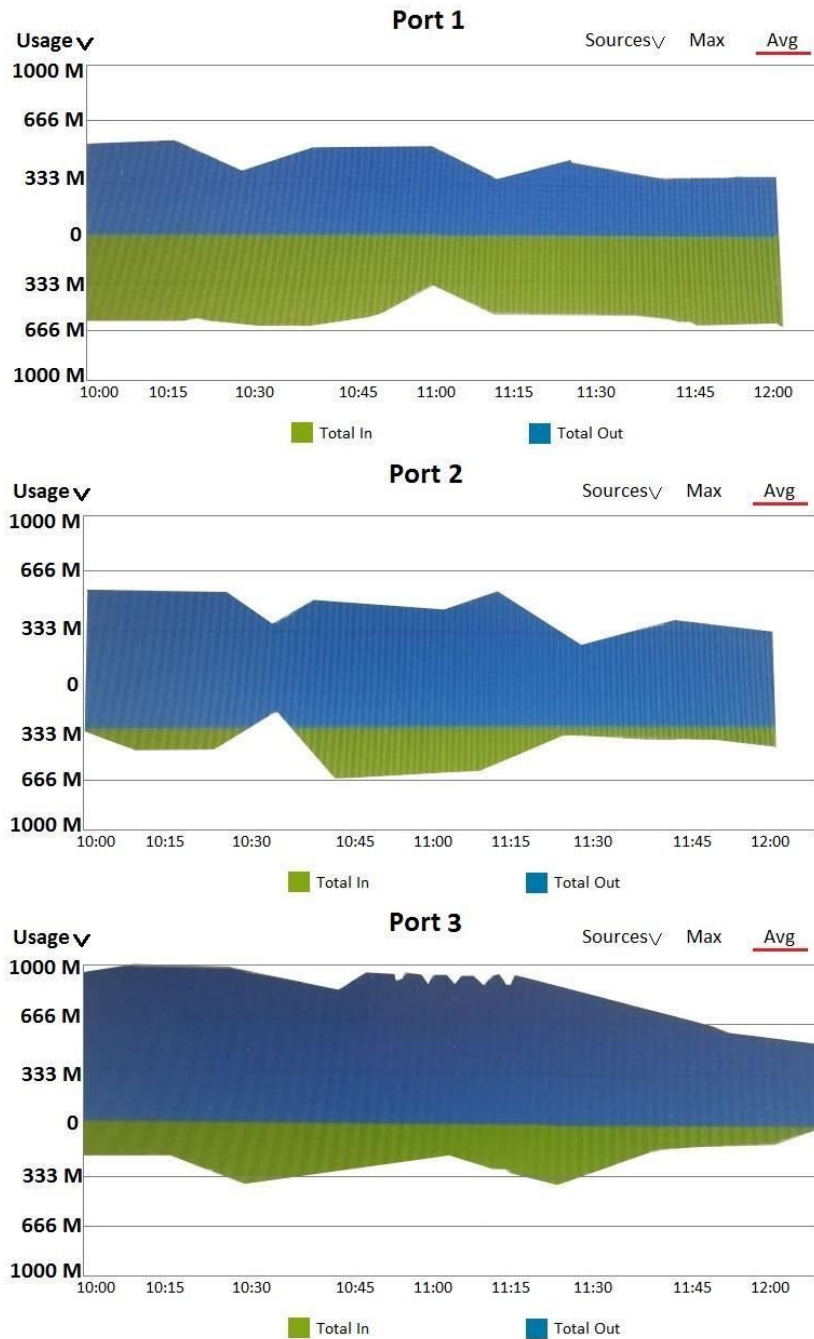

A customer needs a wired network upgrade and has complained about performance issues. The architect has collected information about traffic flow on several switch ports in different locations across the network, and the results are shown in the exhibit. Each of these ports is a 1Gbps port. What can the architect conclude?

- A. None of these ports show any periods of congestion.
- B. Port 1 shows periods of congestion, other ports are not congested.
- C. Port 3 shows periods of congestion, other ports are not congested.
- D. All of the ports show serious congestion.

Answer: D

Question: 46

What is one reason to deploy an Aruba 8320 switch when compared to an Aruba 5400R switch?

- A. to support cloud-based management and guest services through Aruba Central integration
- B. to obtain a great number of options for types of ports, including PoE and non-PoE
- C. to enhance network monitoring and analytics
- D. to support Zero Touch Provisioning (ZTP)

Answer: C

Question: 47

A hospital needs a wireless solution which will provide guest access for patients and visitors, as well as for medical staff. In addition to laptops and tablets, staff have wireless voice communicator devices. Some medical equipment also connects wirelessly.

How can the network architect help to ensure that patient and visitor internet use does not interfere with more vital hospital applications?

- A. Deploy IntroSpect to monitor patient and visitor traffic.
- B. Plan a bandwidth contract for the guest role in the MC firewall.
- C. Deploy dedicated Air Monitors (AMs) at about one-fourth the density of APs.
- D. Ensure that the guest SSID has a password associated with it.

Answer: C

Question: 48

Refer to the exhibit.

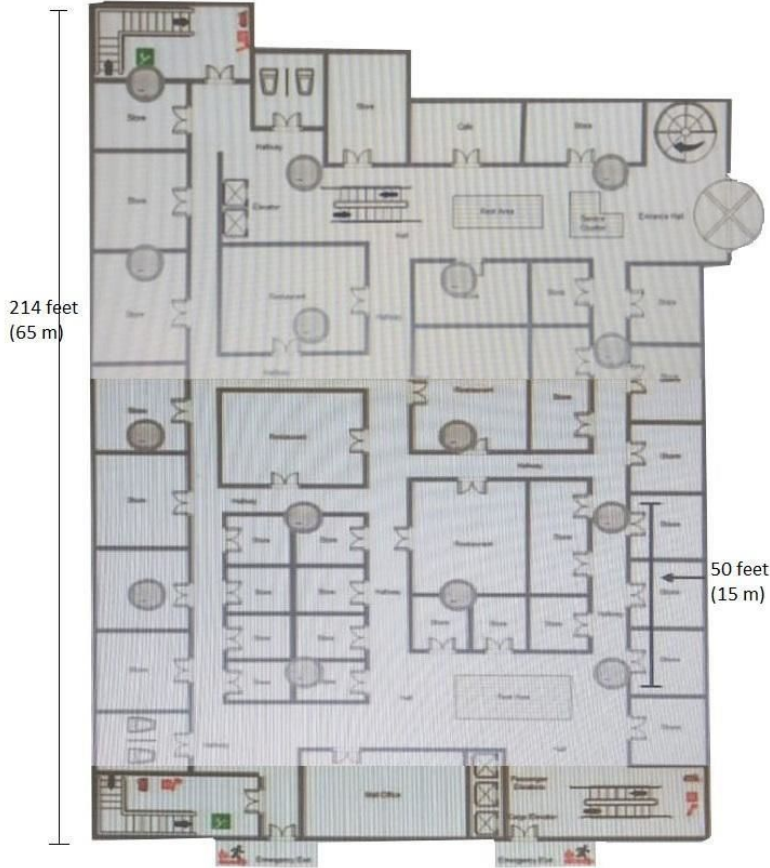

A mall has an existing Aruba solution with 15 AP-335s. The mall now wants to add Meridian and location-based services, in particular blue dot wayfinding. The customer plans to use the built-in beacon in the existing AP radios. These Meridian licenses have been proposed:

1x Aruba Meridian Maps

1x Aruba Meridian Blue Dot Nav

Which concern should the architect raise about this plan?

- A. Separate beacons should be deployed to provide proper coverage for wayfinding.
- B. Only the Blue Dot Nav license is required to meet the customer requirements.
- C. The customer requires wireless sensors to manage the beacons in the AP radios.
- D. The existing AP radios do not support beacon functionality.

Answer: A

Question: 49

Refer to the exhibit.

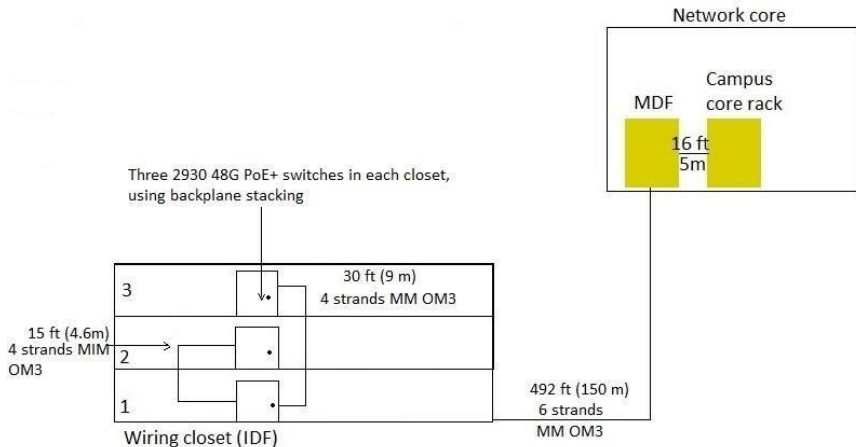

A customer needs a wired upgrade for a building on its main campus. The exhibit shows the switches that architect has selected for each closet and the existing cabling. The customer is not open to changing the cabling.

The customer requires link redundancy for the uplinks from each closet and for the links from the building to the core. In non link failure situations, the uplinks from each closet must support at least 20 Gbps, and the building as a whole must have at least 20 Gbps to the core in non link failure situations.

Which options for connecting the closets to the network core are valid? (Select two.)

- A. Connect the switch stack on each floor directly to the network core on two fiber connections per floor. Achieve this by patching the inter-floor fiber through the inter-building fiber.
- B. Add two aggregation switches in the Floor 1 closet. Connect the switch stack for each closet to the aggregation switches on two fiber links each and the aggregation switches to the core on two fiber links.
- C. Combine the nine switches on all three floors into a single switch stack with stacking cables in a ring topology. Connect two Floor 1 members to the network core with one fiber connection each.
- D. Combine the nine switches on all three floors into a single switch stack with the MM OM3 fiber cables in a ring topology. Connect two Floor 1 members to the network core with one fiber connection each.
- E. Connect the Floor 2 switch stack to Floor 1 with two fiber connections. Do the same for Floor 3. Connect the Floor 1 switch stack to the network core with two fiber connections.

Answer: BC

Question: 50

A customer has phones used as wireless Voice over IP (VoIP) devices. Which is one implication for the design?

- A. Plan policies for the phone role on MCs to give the phones a high QoS priority.
- B. Ensure a -75 GHz signal in both the 2.4GHz band and the 5GHz band across the entire site.
- C. Ensure that APs connect on Smart Rate ports to support the high bandwidth demands of the phones.
- D. Apply a bandwidth contract to the phone VLAN to limit broadcast and multicast traffic.

Answer: C

Question: 51

Refer to the exhibit.

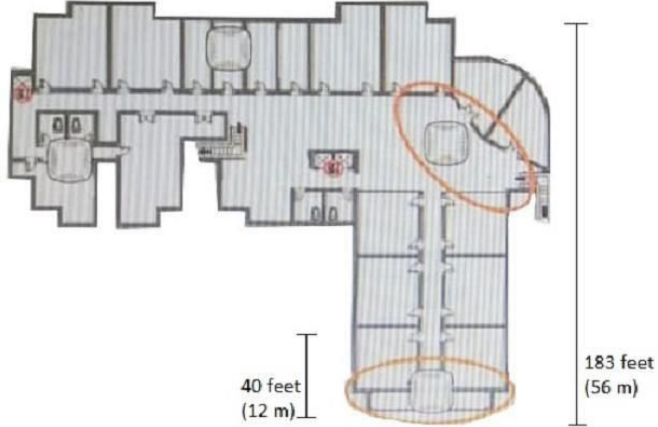

A casino and a retail space has an existing Aruba network with Aruba AP-335s. The customer wants to deploy Meridian and enable proximity-based campaigns. The exhibit shows a segment of the floor plan. When visitors enter the areas circled in the exhibit, they should receive a targeted notification about promotions and sales. What should the architect explain to the customer about how to finish the solution?

- A. This solution will require about 6 battery-powered beacons, which can be managed by the APs.
- B. While these APs cannot act as beacons, they have a USB slot that accepts USB beacons.
- C. The customer can enable the built-in BLE capability in the AP-335 radio to meet these requirements.
- D. The customer must remember to purchase a Meridian Maps license with the Campaigns license.

Answer: A

Question: 52

Refer to the exhibit.

Quotation - Composite View

Line#	Part Number	Description	Manufacturer	Unit Price	Quantity	Total	Price List
1.00	JY680A	Aruba AP-303H (US) Unified AP	Hewlett Packard Enter..	\$495.00	200	\$99,000.00	USA Price List (USD)
1.01	H6PQ1E	Aruba 1Y FC NBD Exch AP-303H SVC [for JY680A]	Hewlett Packard Enter...	\$22.00	200	\$4,400.00	USA Price List (USD)
<b>Quote Total</b>						<b>\$103,400</b>	

A hotel needs a wireless solution. The architect has selected 303H Series, controlled by a local MC, as the best choice. The hotel plans to have the APs installed in the existing wall boxes which have one Ethernet port each. The architect has created a BOM shown in the exhibit. (Note that this portion of the BOM does not include the MC, which is not part of this question.) Which additional clarification should the architect seek to determine whether this BOM fully meets the customer needs?

- A. whether the hotel wants to deploy the APs as RAPs or CAPs
- B. whether the hotel has CAT5e patch cables long enough to reach the boxes
- C. whether directional or omnidirectional external antennas work better for the APs
- D. whether the hotel already has a PoE or PoE+ source

Answer: D

Question: 53

A hospital needs an upgrade to 802.11ac for its wireless network. The wireless network supports:



**Floor 1**

Properties View Edit

**Devices**

APs

**Overlays**

Heatmap

Speed

Voice

**Floorplan Features**

Labels

Origin

Regions

Walls

Signal Cutoff: -56dBm

Frequencies: 5 GHz  24GHz

Floors: Current  Above  Below

Show Overlay as Grid?

– wireless medical devices medical staff voice communicators laptops in nurse stations medical staff tablets  
 – visitor and patient personal devices

All of these devices support both the 2.4GHz and 5GHz band. Assuming about a max throughput of 150 Mbps per AP, the hospital would like to support about 4 Mbps per client. The architect has used VisualRF to plan the AP placement on one of the floors, which the hospital expects will need to support about 800 wireless devices. The exhibits show heatmaps from this plan. The architect also plans to deploy APs in stairwells between floors.

How well does the plan meet the requirements?

- A. The current AP placement fails to account for the lead-lined walls that are common in patient and exam rooms.
- B. The current AP placement fails to provide adequate signal for the voice communicators in several areas.
- C. The current AP placement meets coverage requirements, but does not meet capacity requirements.
- D. The current AP placement meets the customer requirements in terms of coverage and capacity.

Answer: D

Question: 54

An indoor sports stadium has 5,000 seats in two rings:  
 The stadium has a ceiling height of 60 feet (18m).

There is a catwalk around the perimeter of the court, between the court and the seating areas. This catwalk is 40 feet (12m) from the floor. There are two scoreboards at either end of the stadium. The construction of the stadium is concrete and steel.

The customer does not want an under-seat, pico cell deployment, and the customer requires 802.11ac Wave 2. Which AP model is appropriate to provide coverage in the main stadium bowl?

- A. AP-228
- B. AP-344
- C. AP-365
- D. AP-375

Answer: A



Question: 55

Refer to the exhibit.

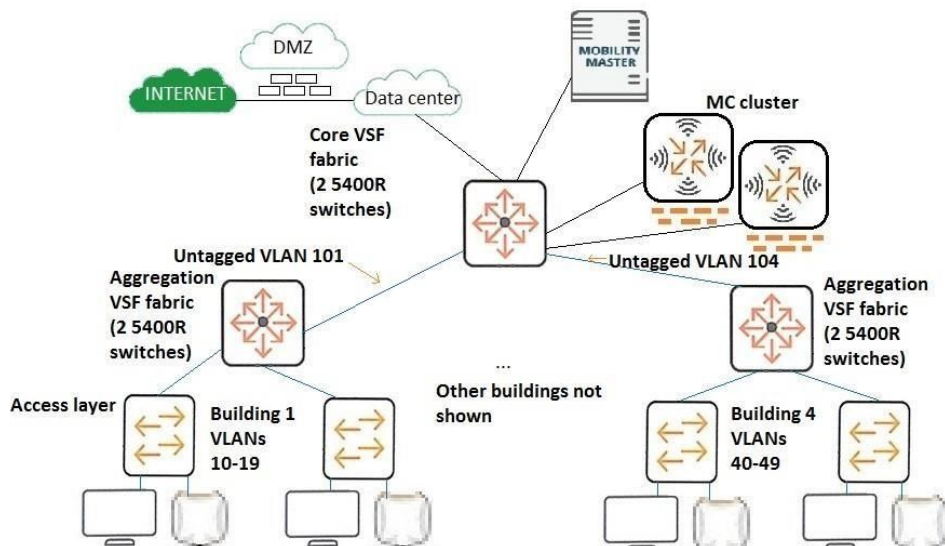

A customer has a wired infrastructure shown in the exhibit. The customer is in the process of expanding their wireless services. They will now add a new wireless solution, with mobility controllers (MCs) connected as shown. The new wireless solution will support a total of 450 APs and about 26,000 wireless devices. It must provide seamless roaming across the entire campus. After the new deployment, both wired and wireless devices experience IP connectivity issues.

- Which change to the existing infrastructure should the architect recommend to support all of the customer requirements?
- A. The MCs should be moved to the aggregation layer, and more MCs added.
  - B. The core and aggregation switches should disable Virtual Switching Framework (VSF).**
  - C. The core switches should be replaced with switches that have larger ARP tables.
  - D. The wired VLANs should be combined into a single VLAN and /16 subnet.

Answer: B

Question: 56

A customer has an existing Aruba network, which currently supports up to 9,000 wireless client devices. The existing network includes these components:

- Four 7210 MCs
- Five 7030 MCs
- 200 AP-303HRs
- 300 AP-345s

The customer wants to convert to an ArubaOS 8.x architecture. The architect plans to deploy a virtual MM.

Which exhibit shows the correct BOM for the MM?

A.

Line#	Part Number	Description	Manufacturer	Unit Price	Quantity	Total	Price List
1.00	JY895AAE	Aruba MM-VA-500 Mobility Master SW E-LTU	Hewlett Packard Enter...	\$10,495.00	1	\$10,495.00	USA Price List (USD)
1.01	HSU09E	Aruba 1Y FC 24x7 MM-VA-500 ELTU SVC [for JY895AAE]	Hewlett Packard Enter...	\$1,616.00	1	\$1,616.00	USA Price List (USD)
1.02	JW471AAE	Aruba-LIC-ENT Enterprise (LIC-AP LIC-PEF LIC-RFP and LIC-...)	Hewlett Packard Enter...	\$300.00	300	\$90,000.00	USA Price List (USD)
1.03	H2XW3E	Aruba 1Y FC 24x7 License On Bundle SVC [for JW471AAE]	Hewlett Packard Enter...	\$46.00	300	\$13,800.00	USA Price List (USD)
<b>Quote Total</b>						<b>\$115,911</b>	

B.

Line#	Part Number	Description	Manufacturer	Unit Price	Quantity	Total	Price List
1.00	JY896AAE	Aruba MM-VA-1K Mobility Master SW E-LTU	Hewlett Packard Enter...	\$17,495.00	1	\$17,495.00	USA Price List (USD)
1.01	HSUE9E	Aruba 1Y FC 24x7 MM-VA-500 ELTU SVC [for JY895AAE]	Hewlett Packard Enter...	\$2,701.00	1	\$2,701.00	USA Price List (USD)
1.02	JW471AAE	Aruba-LIC-ENT Enterprise (LIC-AP LIC-PEF LIC-RFP and LIC-...)	Hewlett Packard Enter...	\$300.00	500	\$150,000.00	USA Price List (USD)
1.03	H2XW3E	Aruba 1Y FC 24x7 License On Bundle SVC [for JW471AAE]	Hewlett Packard Enter...	\$46.00	500	\$23,000.00	USA Price List (USD)
<b>Quote Total</b>						<b>\$193,196</b>	

C.

Line#	Part Number	Description	Manufacturer	Unit Price	Quantity	Total	Price List
1.00	JY896AAE	Aruba MM-VA-1K Mobility Master SW E-LTU	Hewlett Packard Enter...	\$17,495.00	1	\$17,495.00	USA Price List (USD)
1.01	HSUE9E	Aruba 1Y FC 24x7 MM-VA-1K ELTU SVC [for JY896AAE]	Hewlett Packard Enter...	\$2,701.00	1	\$2,701.00	USA Price List (USD)
<b>Quote Total</b>						<b>\$20,196.00</b>	

D.

Quotation - Composite View

Line#	Part Number	Description	Manufacturer	Unit Price	Quantity	Total	Price List
1.00	JY896AAE	Aruba MM-VA-1K Mobility Master SW E-LTU	Hewlett Packard Enter...	\$10,495.00	1	\$10,495.00	USA Price List (USD)
1.01	HSUE9E	Aruba 1Y FC 24x7 MM-VA-1K ELTU SVC [for JY896AAE]	Hewlett Packard Enter...	\$1,616.00	1	\$1,616.00	USA Price List (USD)
1.02	JW471AAE	Aruba LIC-ENT Enterprise (LIC-AP LIC-PEF LIC-RFP and LIC-...	Hewlett Packard Enter...	\$300.00	500	\$150,000.00	USA Price List (USD)
1.03	H2XW3E	Aruba 1Y FC 24x7 License On Bundle SVC [for JW471AAE]	Hewlett Packard Enter...	\$46.00	500	\$23,000.00	USA Price List (USD)
		<b>Quote Total</b>				<b>\$185,111</b>	

Answer: C

Question: 57

A customer has multiple medium and large branch sites, each of which requires between 8 and 16 APs and supports between 200 and 600 wireless clients. Every branch site has an internet connection, which it uses to reach the central data center. The customer would prefer the WAN links to be optimized in the solution. Each side handles between 1 and 2 Gbps of traffic, most of which goes to the central data center. The data center has 7210 controllers for terminating the VPN connections. Which branch office solution best meets the customer needs?

- A. CAPs and branch office controllers with an SD-WAN license
- B. IAPs and no branch office controllers
- C. CAPs and branch office controllers
- D. RAPs and no branch office controllers

Answer: B

Question: 58

Refer to the exhibits.

Exhibit 1. Existing wiring plan:

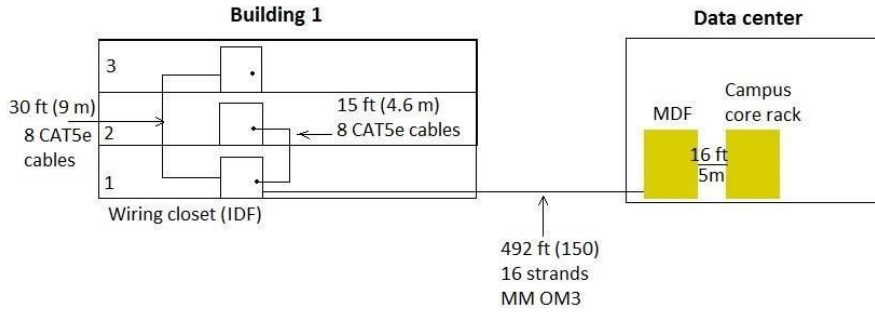

Exhibit: A49.01114316-731

Exhibit 2. Current proposal:

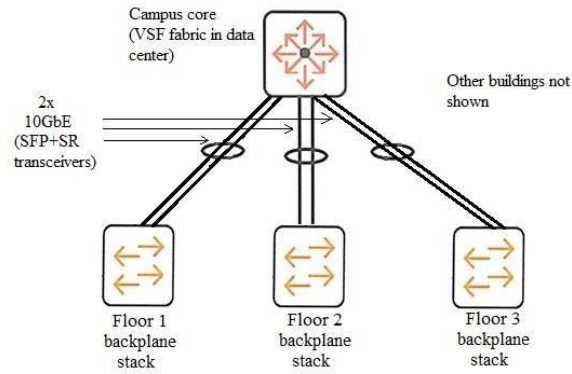

Exhibit: A49.01114316-732

A customer has a building that needs a switch upgrade. The customer would like at least 20Gbps for the uplink bandwidth out of each closet. The building wiring plan is shown in Exhibit 1. The customer will not consider any cable upgrades at this point. The current proposal is shown in Exhibit 2.

Which correction must architect make to the proposal to meet the customer requirements?

- A. Change the SR transceivers for each link between the writing closet switches and the network core to LRM transceivers.
- B. Add an aggregation layer, and connect writing closet switches to the aggregation layer on Smart Rate ports.
- C. Add an aggregation layer, and connect writing closet switches to the aggregation layer with SFP+ SR transceivers.
- D. Add a mode conditioning cable for each link between the writing closet switches and the network core.

Answer: D

Question: 59

What is one customer requirement that can drive the need for a relatively dense AP deployment, in which the coverage areas of at least three AP radios overlap?

- A. support for beacon management
- B. AP operation as hybrid AMs for IDS/WIPS
- C. the deployment of dual 5GHz radio APs
- D. location tracking of wireless IoT devices

Answer: D

Question: 60

Refer to the exhibit.

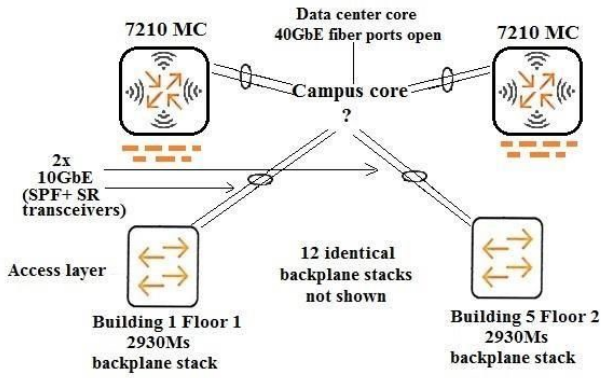

Exhibit: A49.01114316-77

An architect has planned the wireless and wired access layers for a network upgrade. The entire solution must support 9,000 wireless devices and 2,250 wired endpoints. The campus core must meet these requirements: no more than 4:1 oversubscription on the links to the data center switch-level redundancy near instant failover if one core switch fails link aggregations between access layer and core same switch software used across the entire campus Which exhibit shows a campus core that meets the customer needs?

A.

Line#	Part Number	Description	Manufacturer	Unit Price	Quantity
1.00	JL095A	Aruba 5406R 16SFP+ v3 z12 Switch	Hewlett Packard Enter...	\$9,599.00	2
1.01	J9993A	INCLUDED: Aruba 8p 1G-10GbE SFP+ v3 z12 Mod	Hewlett Packard Enter...	Incl.	4
1.02	HIMT0E	HPE 3Y FC 24x7 Aruba 5406R z12 Switch SVC [for JL095A]	Hewlett Packard Enter...	\$4,094.00	2
1.03	U4832E	HPE Networks 54xx/82xx z1 Startup SVC [for JL095A]	Hewlett Packard Enter...	\$2,325.00	2
1.04	J9828A	Aruba 5400R 700W PoE+ z12 PSU	Hewlett Packard Enter...	\$799.00	2
1.05	J9828A ABA	INCLUDED: Power Card - U.S. localization	Hewlett Packard Enter...	Incl.	2
1.06	J91500	Aruba 10G SFP+ LC SR 300m MMF Transceiver	Hewlett Packard Enter...	\$1,040.00	32
1.07	J9996A	Aruba 2p 40GbE QSFP+ LC BiDi 150m MMF 2-strand Transceiver	Hewlett Packard Enter...	\$6,799.00	4
1.08	JL308A	Aruba 40G QSFP+ LC BiDi 150m MMF 2-strand Transceiver	Hewlett Packard Enter...	\$1,095.00	2
2.00	JH234A	HPE X242 40G QSFP+ to QSFP+ 1m DAC Cable	Hewlett Packard Enter...	\$419.00	2
<b>Quote Total</b>					

B.

Line#	Part Number	Description	Manufacturer	Unit Price	Quantity
1.00	JL095A	Aruba 5406R 16SFP+ v3 z12 Switch	Hewlett Packard Enter...	\$9,599.00	2
1.01	J9993A	INCLUDED: Aruba 8p 1G-10GbE SFP+ v3 z12 Mod	Hewlett Packard Enter...	Incl.	4
1.02	HIMT0E	HPE 3Y FC 24x7 Aruba 5406R z12 Switch SVC [for JL095A]	Hewlett Packard Enter...	\$4,094.00	2
1.03	U4832E	HPE Networks 54xx/82xx z1 Startup SVC [for JL095A]	Hewlett Packard Enter...	\$2,325.00	2
1.04	J9828A	Aruba 5400R 700W PoE+ z12 PSU	Hewlett Packard Enter...	\$799.00	2
1.05	J9828A ABA	INCLUDED: Power Card - U.S. localization	Hewlett Packard Enter...	Incl.	2
1.06	J91500	Aruba 10G SFP+ LC SR 300m MMF Transceiver	Hewlett Packard Enter...	\$1,040.00	32
1.07	J9996A	Aruba 2p 40GbE QSFP+ LC BiDi 150m MMF 2-strand Transceiver	Hewlett Packard Enter...	\$6,799.00	4
1.08	JL308A	Aruba 40G QSFP+ LC BiDi 150m MMF 2-strand Transceiver	Hewlett Packard Enter...	\$1,095.00	2
<b>Quote Total</b>					

C.

Line#	Part Number	Description	Manufacturer	Unit Price	Quantity
1.00	JL479A	Aruba 8320 48 10/6 40 X475 5 2 Bundle	Hewlett Packard Enter...	\$24,995.00	2
1.01	JL479A ABA	INCLUDED: Power Card - U.S. localization	Hewlett Packard Enter...	Incl.	2
1.02	H8XX5E	HPE 3Y FC 24x7 Aruba 8320 SWT SVC [for JL479A]	Hewlett Packard Enter...	\$8,093.00	2
1.03	J9150D	Aruba 10G SFP+ LC SR 300m MMF Transceiver	Hewlett Packard Enter...	\$1,040.00	32
1.04	JL30BA	Aruba 40G QSFP+ LC BDI 150m MMF 2-strand Transceiver	Hewlett Packard Enter...	\$1,095.00	2
2.00	JH234A	HPE X242 40G QSFP+ to QSFP+ 1m DAC Cable	Hewlett Packard Enter...	\$419.00	2
<b>Quote Total</b>					

D.

Line#	Part Number	Description	Manufacturer	Unit Price	Quantity
1.00	JL479A	Aruba 8320 48 10/6 40 X475 5 2 Bundle	Hewlett Packard Enter...	\$24,995.00	2
1.01	JL479A ABA	INCLUDED: Power Card - U.S. localization	Hewlett Packard Enter...	Incl.	2
1.02	H8XX5E	HPE 3Y FC 24x7 Aruba 8320 SWT SVC [for JL479A]	Hewlett Packard Enter...	\$8,093.00	2
1.03	J9150D	Aruba 10G SFP+ LC SR 300m MMF Transceiver	Hewlett Packard Enter...	\$1,040.00	32
1.04	JL30BA	Aruba 40G QSFP+ LC BDI 150m MMF 2-strand Transceiver	Hewlett Packard Enter...	\$1,095.00	2
<b>Quote Total</b>					

Answer: B



# SAMPLE QUESTIONS



*These questions are for demo purpose only. **Full version** is up to date and contains actual questions and answers.*

*Killexams.com is an online platform that offers a wide range of services related to certification exam preparation. The platform provides actual questions, exam dumps, and practice tests to help individuals prepare for various certification exams with confidence. Here are some key features and services offered by Killexams.com:*



**Actual Exam Questions:** *Killexams.com provides actual exam questions that are experienced in test centers. These questions are updated regularly to ensure they are up-to-date and relevant to the latest exam syllabus. By studying these actual questions, candidates can familiarize themselves with the content and format of the real exam.*

**Exam Dumps:** *Killexams.com offers exam dumps in PDF format. These dumps contain a comprehensive collection of questions and answers that cover the exam topics. By using these dumps, candidates can enhance their knowledge and improve their chances of success in the certification exam.*

**Practice Tests:** *Killexams.com provides practice tests through their desktop VCE exam simulator and online test engine. These practice tests simulate the real exam environment and help candidates assess their readiness for the actual exam. The practice tests cover a wide range of questions and enable candidates to identify their strengths and weaknesses.*

**Guaranteed Success:** *Killexams.com offers a success guarantee with their exam dumps. They claim that by using their materials, candidates will pass their exams on the first attempt or they will refund the purchase price. This guarantee provides assurance and confidence to individuals preparing for certification exams.*

**Updated Content:** *Killexams.com regularly updates its question bank and exam dumps to ensure that they are current and reflect the latest changes in the exam syllabus. This helps candidates stay up-to-date with the exam content and increases their chances of success.*

**Technical Support:** *Killexams.com provides free 24x7 technical support to assist candidates with any queries or issues they may encounter while using their services. Their certified experts are available to provide guidance and help candidates throughout their exam preparation journey.*

For More exams visit <https://killexams.com/vendors-exam-list>  
*Kill your exam at First Attempt.... Guaranteed!*